



DURANOĞULLARI BETON ELEMANLARI

www.duranogullari.com



*“Taqı
Sanatq dönüştürür.”*





DURANOĞULLARI BETON ELEMANLARI

Duranoğulları Beton Elemanları, sektörde 40. Yılını tamamlamış Duran ailesinin bir markasıdır.

1980'lerin ortasında Ankara'da inşaat malzemeleri satışıyla başlayan ticari faaliyetler, ailenin kurucu jenerasyonunun beton elemanları üretimine geçişi ile sanayileşti.

Günde 100 m²/gün parke taş üretim kapasitesiyle başlayan bu sanayileşme süreci, 2.000 yılında ikinci jenerasyonun yönetimi devralması ve beraberinde yapılan atılımlarla hız kazandı.

Üretimde tesisleşmenin önünü açan 150.000 m²'lik Çubuk Fabrika kampüsüne taşınma süreciyle birlikte, Alman ve İtalyan teknolojisinin en yeni makinelerinin kullanıldığı 2. ve 3. parke taşı tesislerinin ve 2015 yılında da karo üretim tesisinin açılmasıyla değişen ve gelişen şirket, üretim ve hizmet kapasitesini inşaat sektöründe farklı alanlardaki müşterilerinin talep ve beklentilerine de uygun olarak, yıllar içinde düzenli olarak arttırdı.

Duranoğulları Beton Elemanları 2023 yılında tamamladığı yatırımlarla birlikte, 20.000 m² kapalı alana kurulu 3'ü parke taşı ve 2'si karo olmak üzere 5 üretim tesisinde toplam 15.000 m²/gün üretim kapasitesine ulaşan ve 25 araçlık, otomatik yükleme-indirme vinci sistemli tır filosuyla adrese teslim lojistik hizmeti sağlayan entegre bir yapıya dönüştü.

DURANTAŞ markasıyla da bilinen Duranoğulları Beton Elemanları, ülkenin en önemli üretim kapasitelerinden birine sahip olan ve yapılan yatırımlarla da sürekli geliştirdiği tesisleriyle;

"TAŞI SANATA DÖNÜŞTÜRMEYE" devam etmektedir...



www.duranogullari.com



*İnsan
Odaklıdır*



*Hizmet Sonrası
Destekte Zirvede*



*Global Dünyayı
Takip Eder*



*Hep Yükselen
Bir İvme İzmele
Amacındadır*



*Mutlu Çalışanları
Hedefler*



*Projeleri Kusursuz
Hayata Geçirme
Yetisindedir*



*Müşteri İstekleri
Değerli*



*Çevre Dostu
Üretim İlkesidir*



*Hizmet Öncesi
Destek Önemlidir*



*Hızlı Sevkiyatlar
ile Zamanı
Değerlendirir*



*Baştan Sona
Kalite Takibi
Hedefidir*



*Yüksek Üretim
Kapasitesine
Sahiptir*

İÇ MEKAN SİLİMLİ TERRAZO KARO

SİLİMLİ
KARO

DK 101

SİLİMLİ
KARO

DK 102

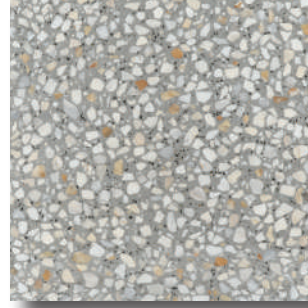
SİLİMLİ
KARO

DK 103

SİLİMLİ
KARO

DK 201

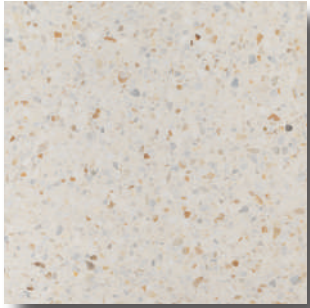
SİLİMLİ
KARO

DK 202

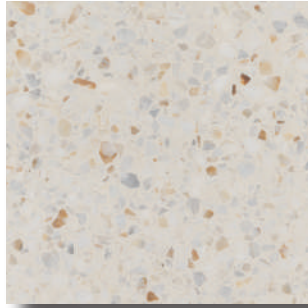
SİLİMLİ
KARO

DK 203

SİLİMLİ
KARO

DK 203-İ

SİLİMLİ
KARO

DK 205

SİLİMLİ
KARO

DK 205-N

SİLİMLİ
KARO

DK 207

SİLİMLİ
KARO

DK 212

SİLİMLİ
KARO

DK 212-S

SİLİMLİ
KARO

DK 212-NÇ

SİLİMLİ
KARO

DK 212-K

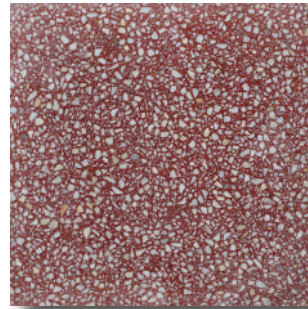
SİLİMLİ
KARO

DK 305

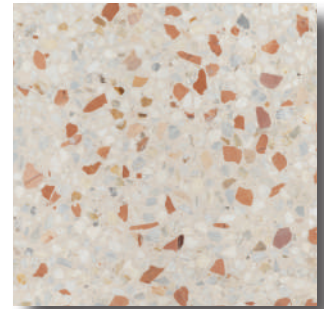
SİLİMLİ
KARO

DK 306

Silimli Karo Ürünlerinde 30x30 - 33x33 - 40x40 - 30x60 - 60x60 ve diğer ölçülerde de isteğe göre üretim yapılabilir.

İÇ MEKAN SİLİMLİ TERRAZO KARO

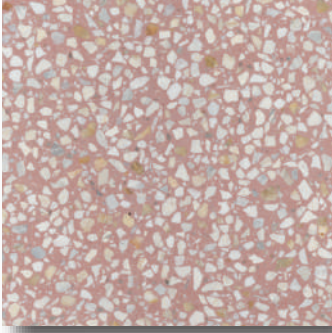
SİLİMLİ
KARO

DK 307

SİLİMLİ
KARO

DK 401-NÇ

SİLİMLİ
KARO

DK 401-K

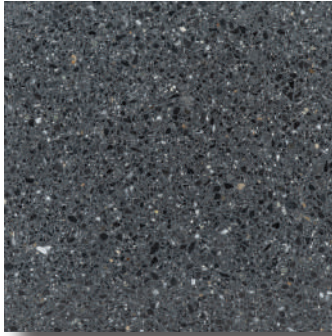
SİLİMLİ
KARO

DK 402

SİLİMLİ
KARO

DK 402-K

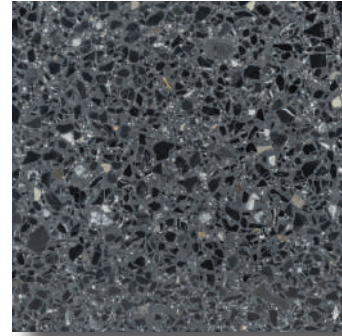
SİLİMLİ
KARO

DK 414-S

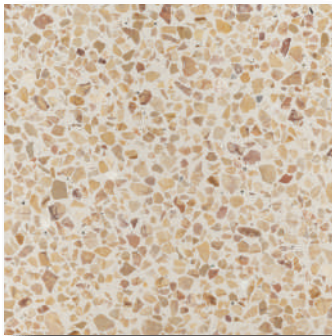
SİLİMLİ
KARO

DK 420

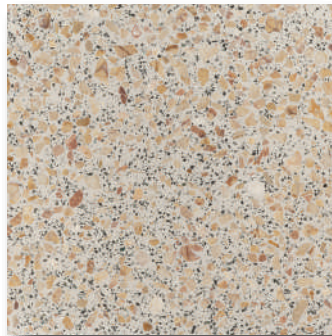
SİLİMLİ
KARO

DK 420-İ

Silimli Karo Ürünlerinde 30x30 - 33x33 - 40x40 - 30x60 - 60x60 ve diğer ölçülerde de isteğe göre üretim yapılabilir.

PATINATO TERRAZO KARO



Patinato uygulaması tüm silimli terrazo karolara uygulanabilir.

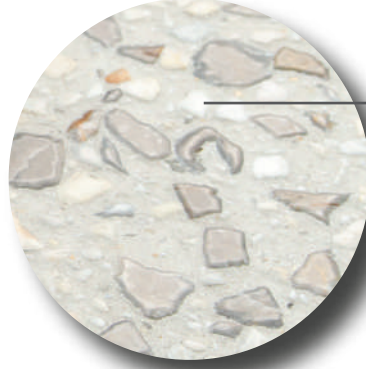

Patinatolu yüzey



TERRAZO SEHPA



DIŐ MEKAN KUMLAMALI TERRAZO KAROLAR

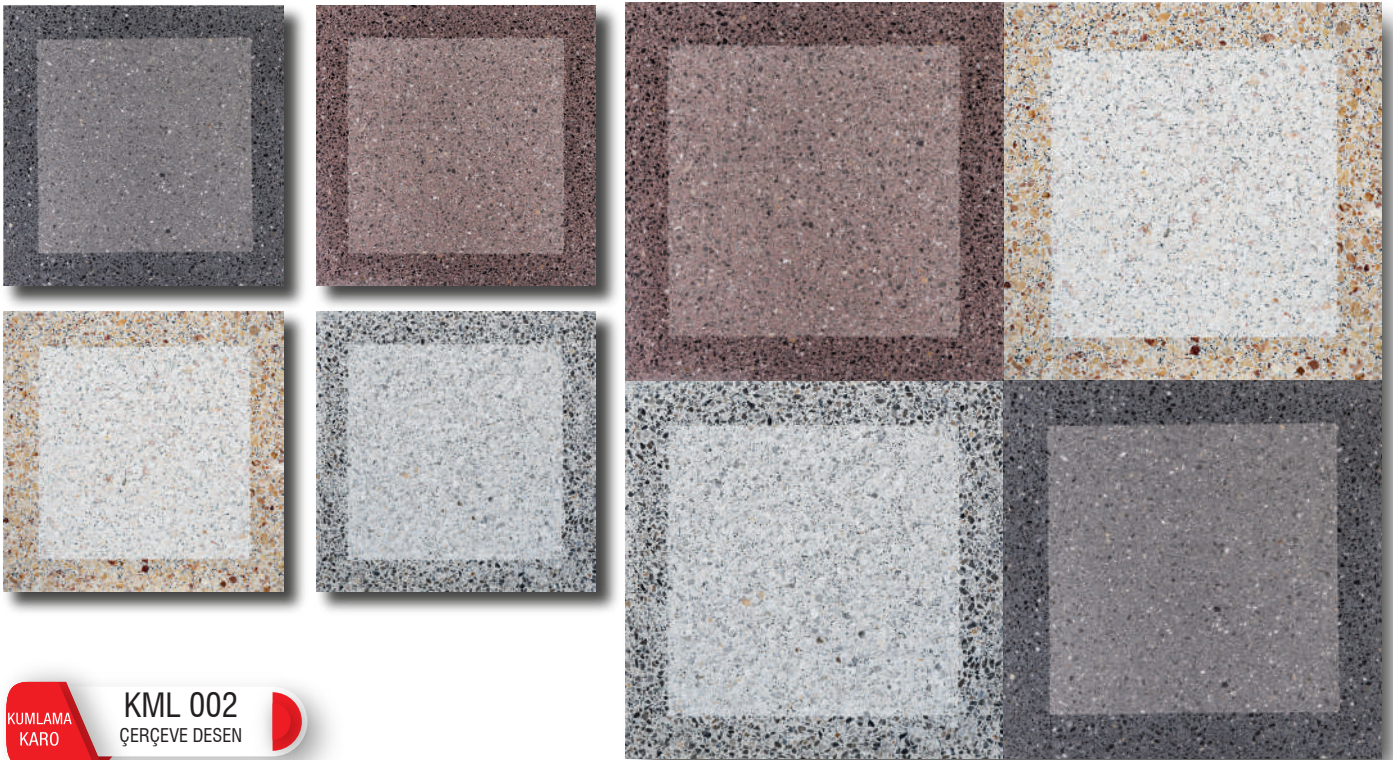
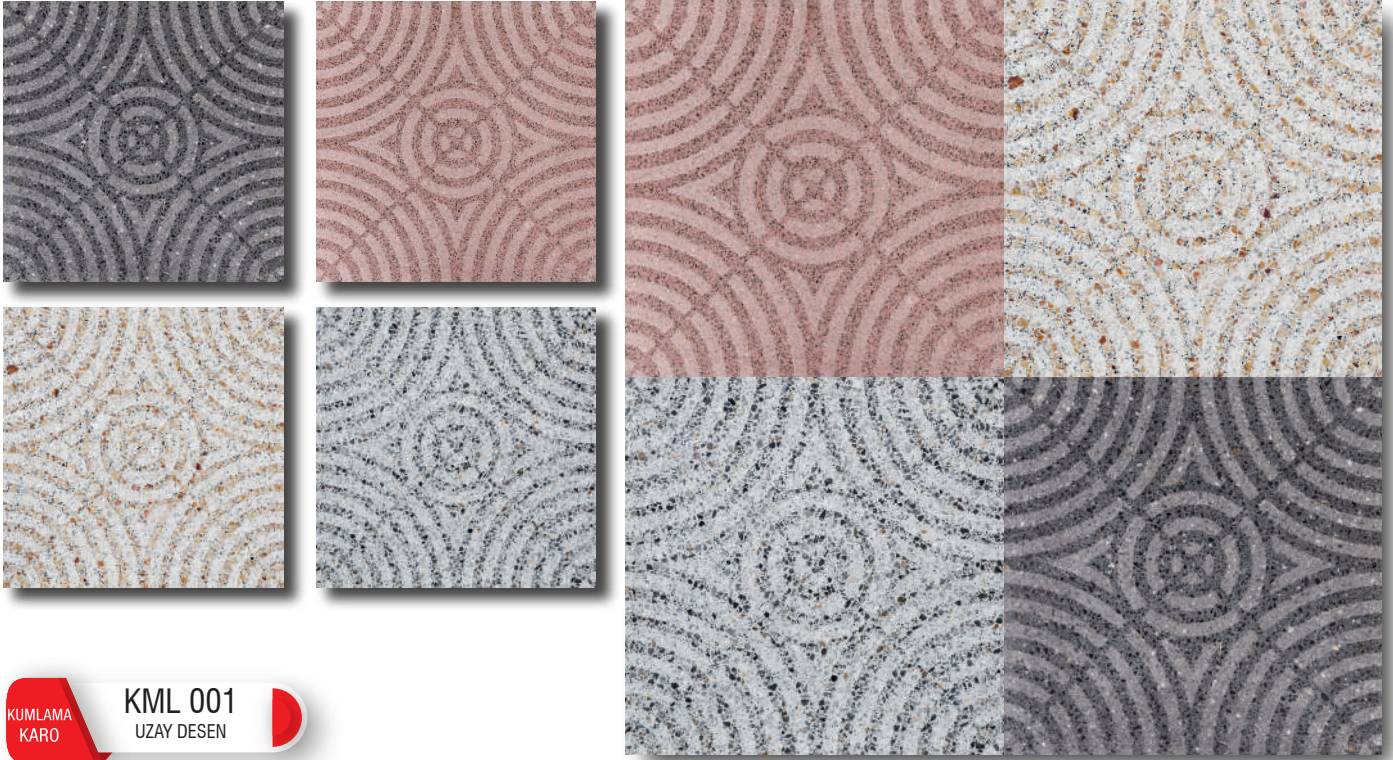

Kuclamalı Karo Ürünlerinde 30x30 - 40x40 - 30x60 - 60x60 ve diđer ölçülerde de isteđe göre üretim yapılabilir.

DIŐ MEKAN KUMLAMALI TERRAZO KAROLAR

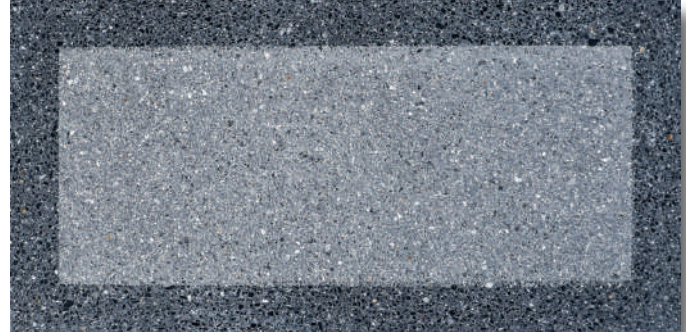
SİLİMLİ
KAROKML 002-B
30x60 ÇERÇEVE DESEN BEYAZSİLİMLİ
KAROKML 002-S
30x60 ÇERÇEVE DESEN SİYAHSİLİMLİ
KARO

30x60 SİLİMLİ SİYAH

SİLİMLİ
KARO

30x60 SİLİMLİ BEYAZ

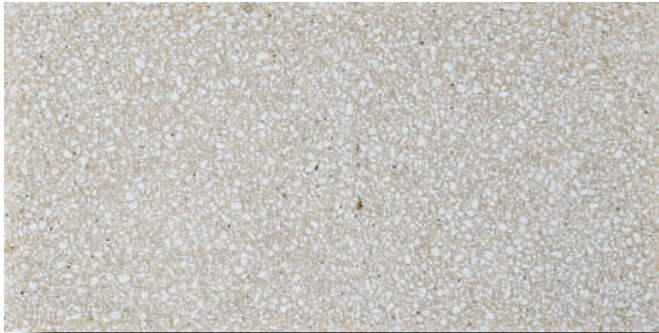
KUMLAMA
KAROKML 002-TK
TÜM KUMLAMA

Kuclamalı Karo Ürünlerinde 30x30 - 40x40 - 30x60 - 60x60 ve diğer ölçülerde de isteğe göre üretim yapılabilir.

DIŐ MEKAN KUMLAMALI TERRAZO KAROLAR

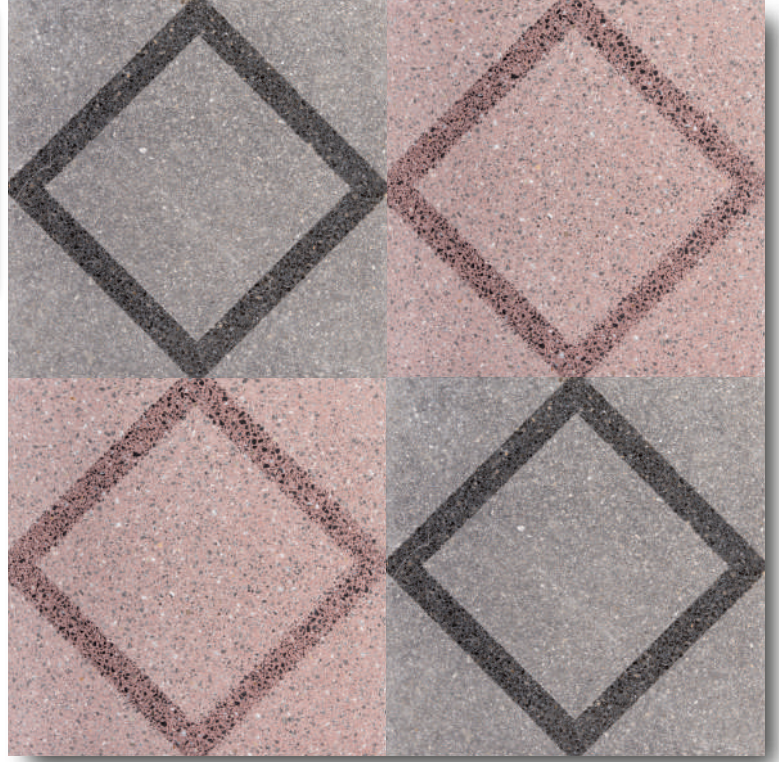
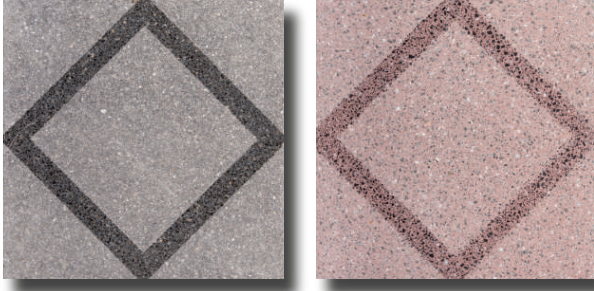

KUMLAMA
KARO

KML 003
BAKLAVA DESEN

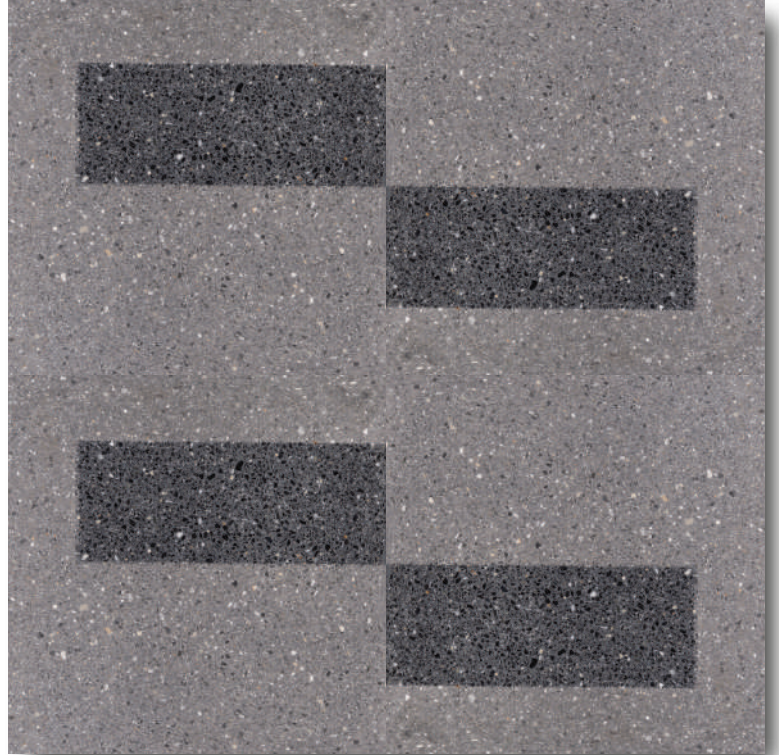
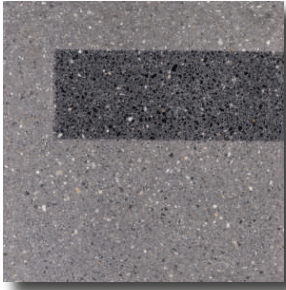

KUMLAMA
KARO

KML 004
PIYANO DESEN

DIŐ MEKAN KUMLAMALI TERRAZO KAROLAR

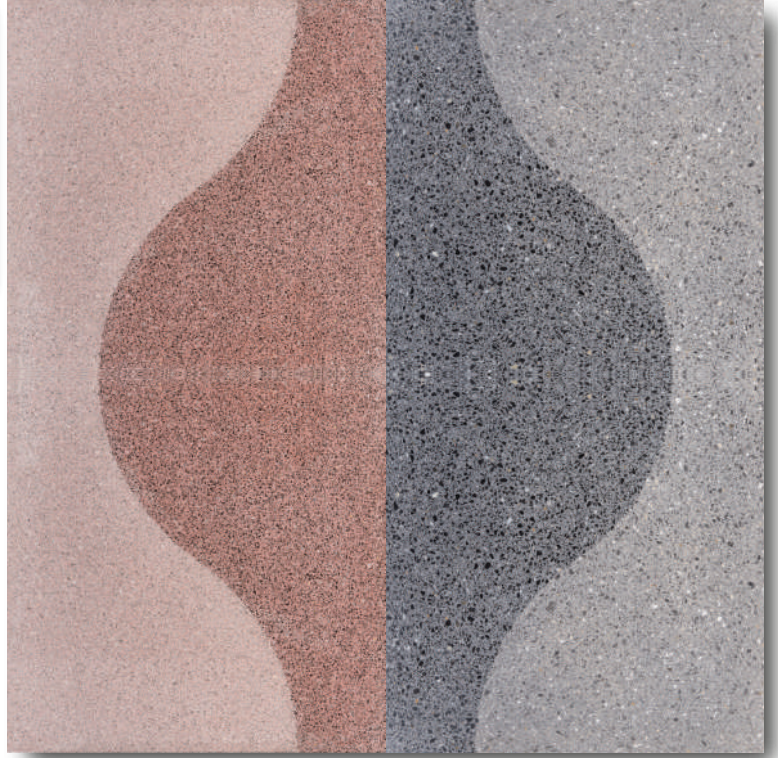

KUMLAMA
KARO

KML 005
SU DESEN

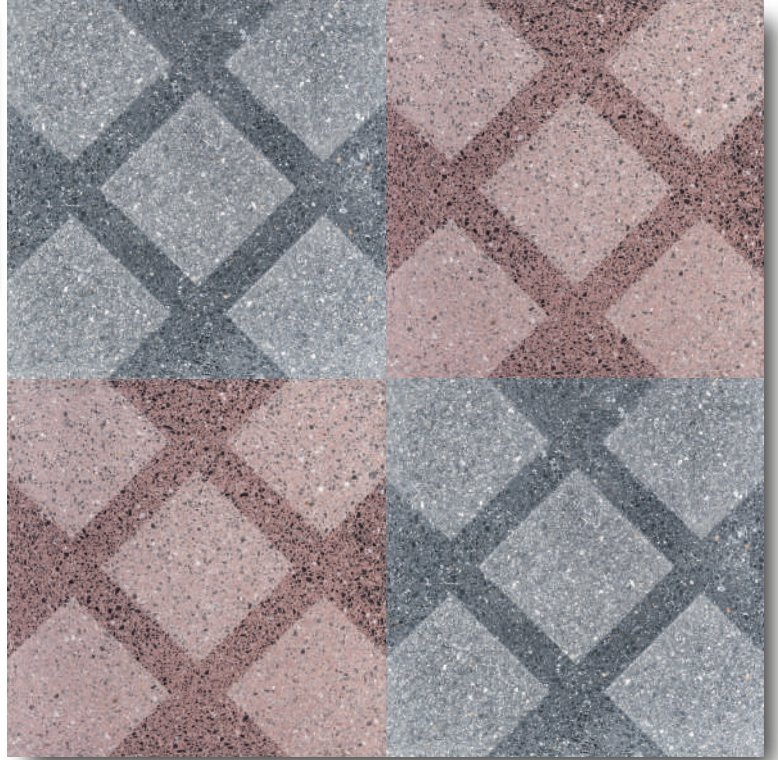

KUMLAMA
KARO

KML 006
DİAGONAL DESEN

Kuclamalı Karo Ürünlerinde 30x30 - 40x40 - 30x60 - 60x60 ve diğer ölçülerde de isteğe göre üretim yapılabilir.

DIŐ MEKAN KUMLAMALI TERRAZO KAROLAR



KUMLAMA
KARO

KML 007
DAMA DESEN



KUMLAMA
KARO

KML 008
ÇAPRAZ DESEN



Kuclamalı Karo Ürünlerinde 30x30 - 40x40 - 30x60 - 60x60 ve diđer ölçülerde de isteğe göre üretim yapılabilir.

DIŐ MEKAN KUMLAMALI TERRAZO KAROLAR



KUMLAMA
KARO

KML 009
DALGA DESEN

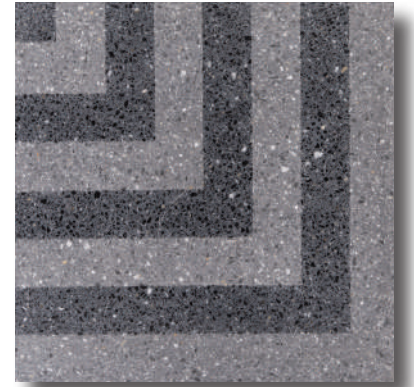
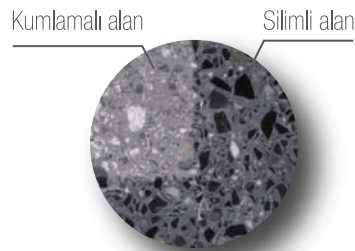
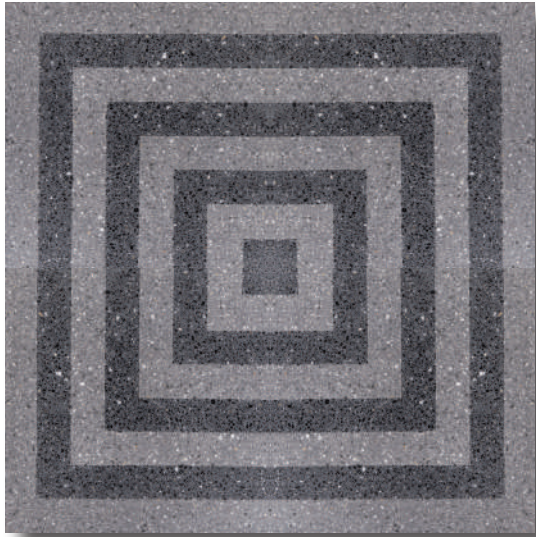

KUMLAMA
KARO

KML 010
PİRAMİT DESEN

Kumlamalı Karo Ürünlerinde 30x30 - 40x40 - 30x60 - 60x60 ve diđer ölçülerde de isteđe göre üretim yapılabilir.

DIŐ MEKAN KUMLAMALI TERRAZO KAROLAR

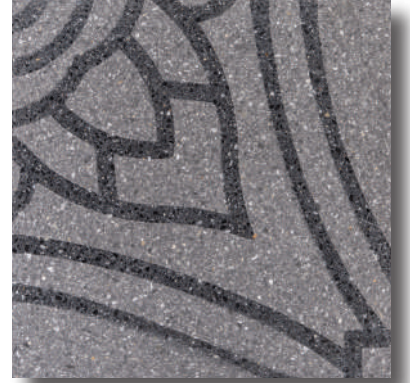
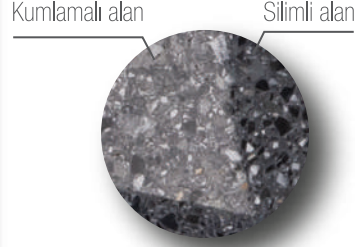

KUMLAMA
KARO

KML 011
BEGONYA DESEN

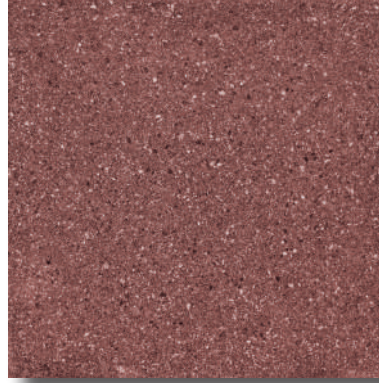
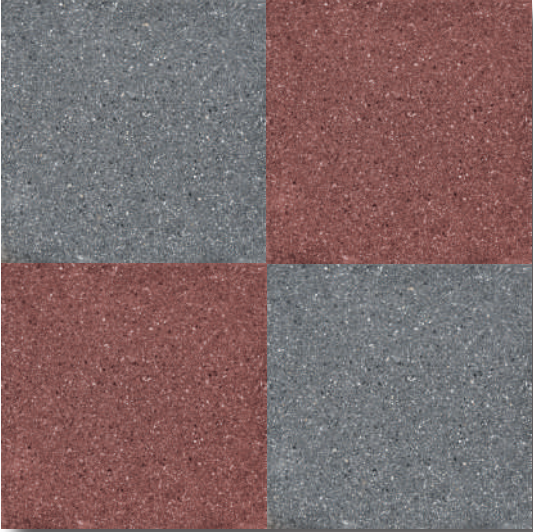

KUMLAMA
KARO

KML 012
TÜM KUMLAMALI

Kumlamalı Karo Ürünlerinde 30x30 - 40x40 - 30x60 - 60x60 ve diđer ölçülerde de isteđe göre üretim yapılabilir.

DIŐ MEKAN KUMLAMALI KARO

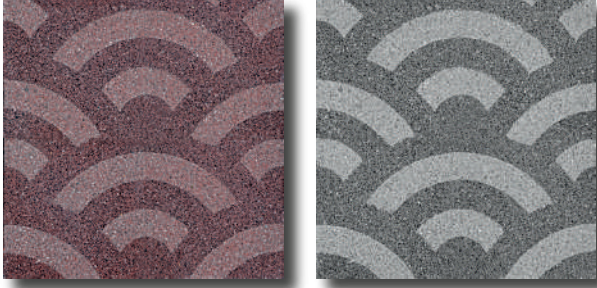

KUMLAMA
KARO

KML 013
YAKAMOZ DESEN

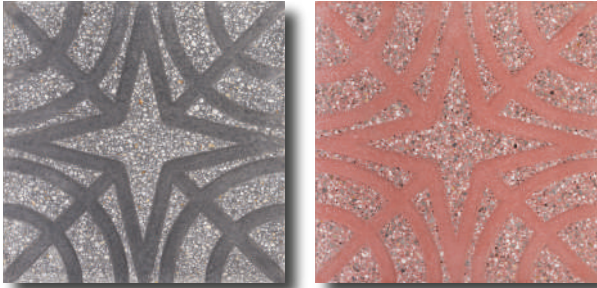

ÖZEL SERİ
KARO

SİLİMLİ
YILDIZ DESEN

Özel Seri Karo Ürünlerinde 30x30 - 40x40 - 60x60 ve diğer ölçülerde de isteğe göre üretim yapılabilir.

DIŐ MEKAN ÖZEL SERİ TERRAZO KAROLAR

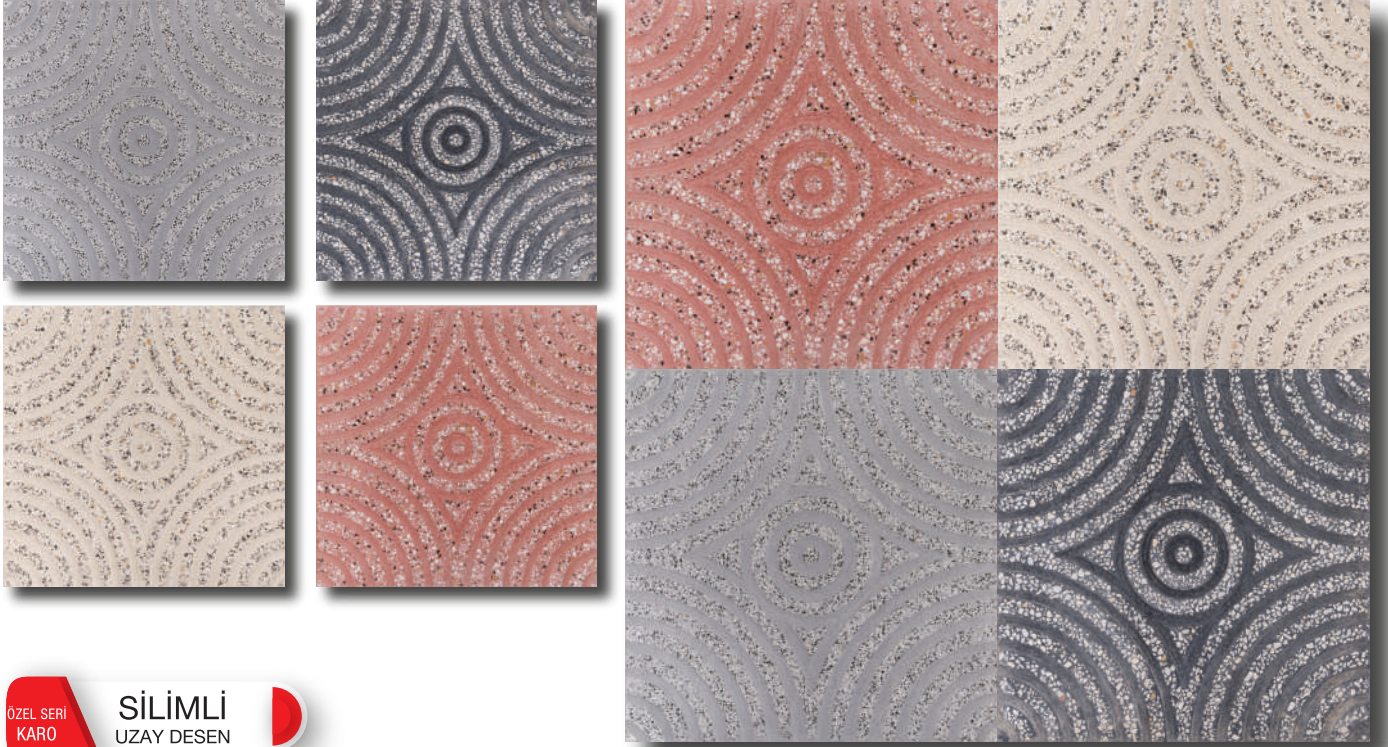

ÖZEL SERİ
KARO

SİLİMLİ
UZAY DESEN



UYGULAMALAR



Kuclamalı Karo Ürünlerinde 30x30 - 40x40 - 30x60 - 60x60 ve diđer ölçülerde de isteęe göre üretim yapılabilir.

DIŐ MEKAN ÖZEL SERİ TERRAZO KAROLAR

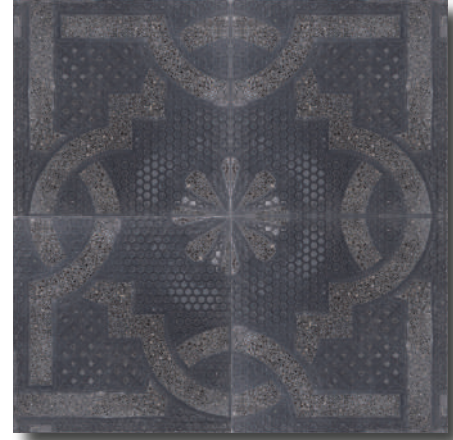
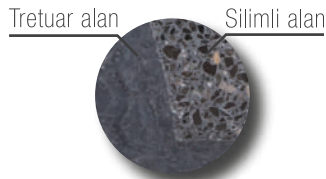
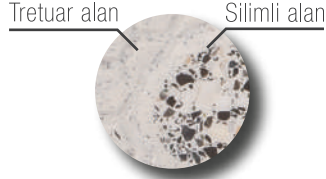

ÖZEL SERİ
KARO **SİLİMLİ**
GONCA DESEN

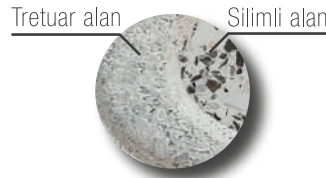

ÖZEL SERİ
KARO **SİLİMLİ**
SARMAŐIK DESEN

DIŐ MEKAN WASCH BETON TERRAZO KAROLAR



WASCH
BETON
KARO **DK 611**
BEYAZ MOZAIK



WASCH
BETON
KARO **DK 612**
SİYAH MOZAIK



WASCH
BETON
KARO **DK 613**
SİYAH MOZAIK

Özel Seri Karo Ürünlerinde 30x30 - 40x40 - 60x60 ve diđer ölçülerde de isteęe göre üretim yapılabilir.

DIŐ MEKAN WASCH BETON TERRAZO KAROLAR

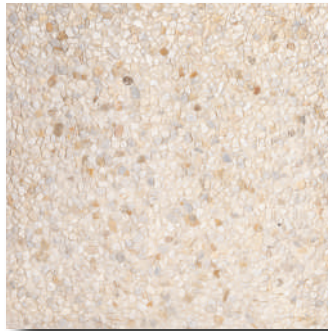
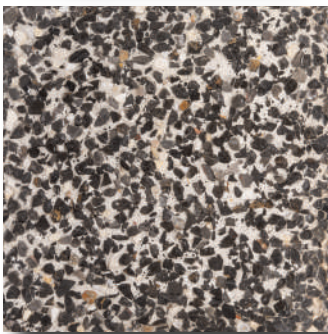
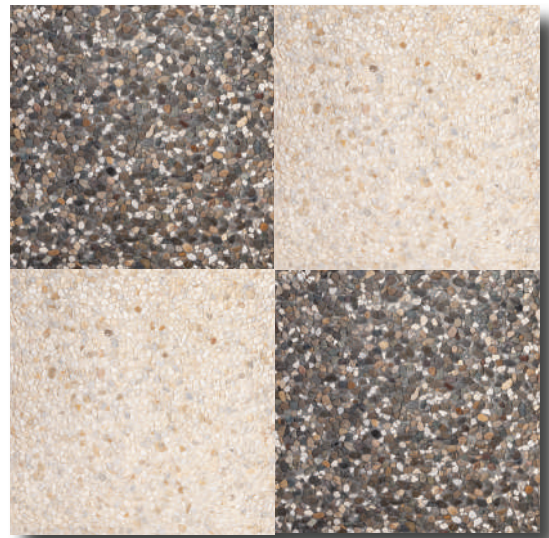
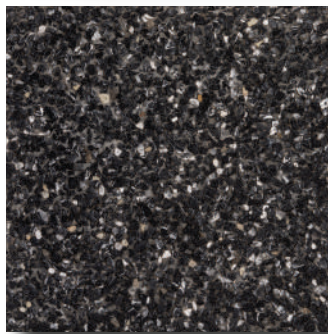
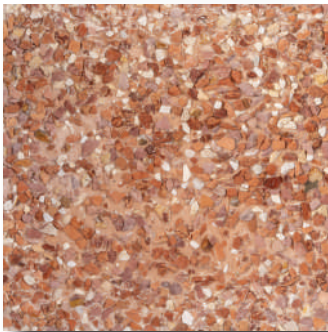
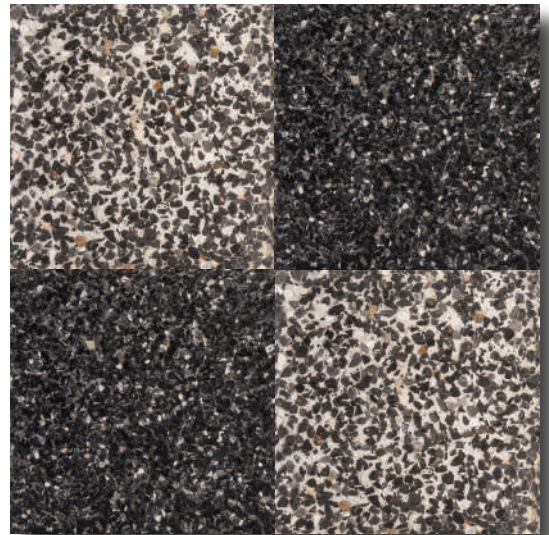
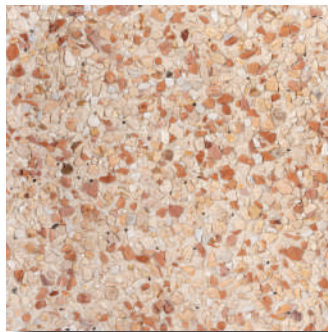
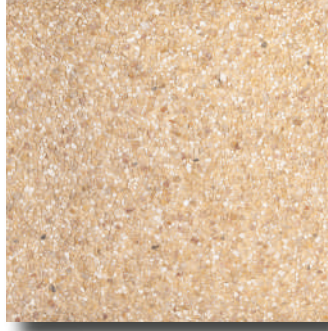
WASCH
BETON
KARODK 601
DERE AKILLIWASCH
BETON
KARODK 605
BEYAZ MOZAIKWASCH
BETON
KARODK 609-B
SİYAH MOZAIKWASCH
BETON
KARODK 609-N
SİYAH MOZAIKWASCH
BETON
KARODK 606
KIRMIZI MOZAIKWASCH
BETON
KARODK 606-B
KIRMIZI MOZAIKWASCH
BETON
KARODK 603-N
N MOZAIKWASCH
BETON
KARODK 610
SARI MOZAIK

DIŐ MEKAN TRETUAR TERRAZO

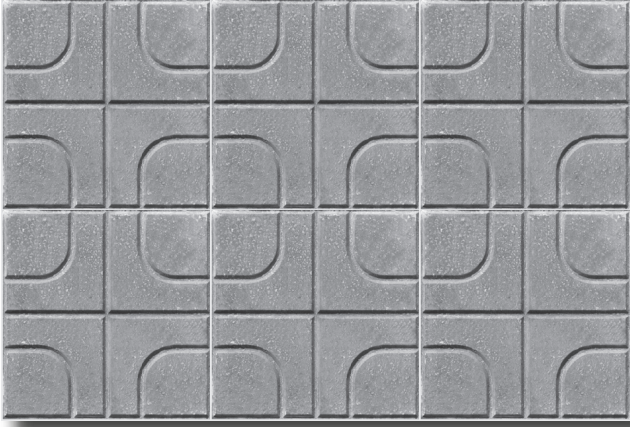
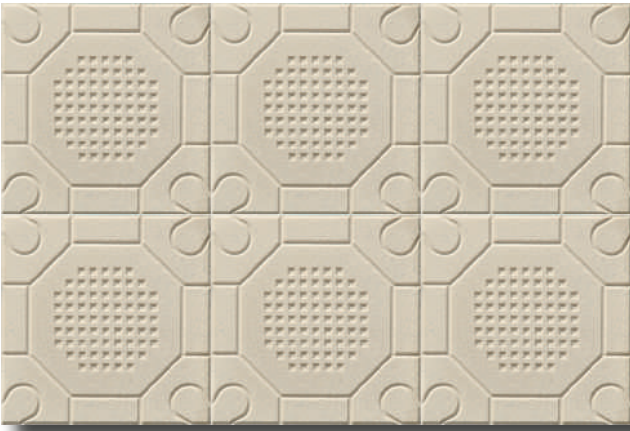
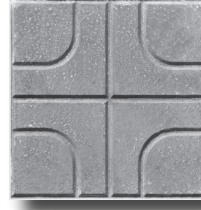
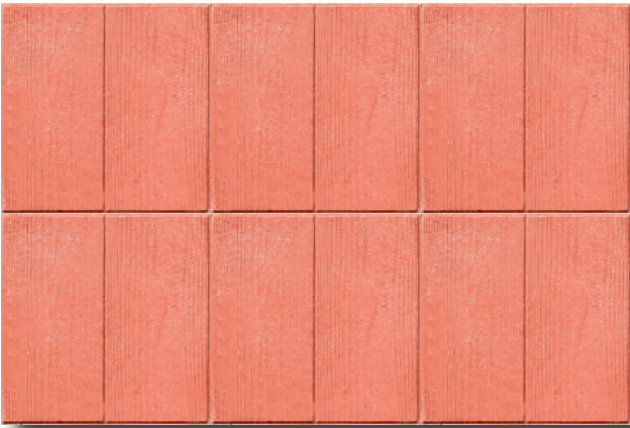
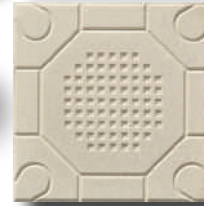
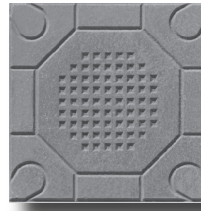
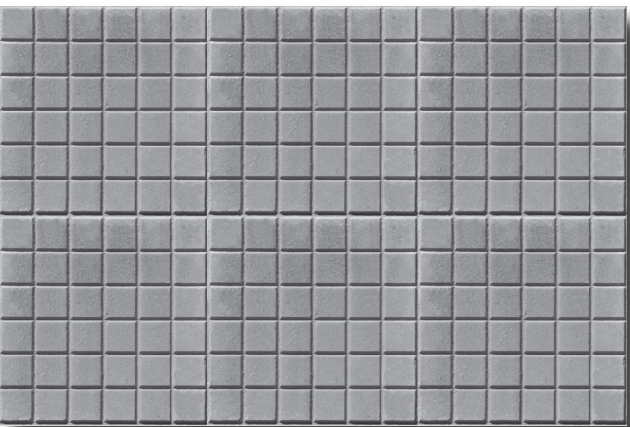
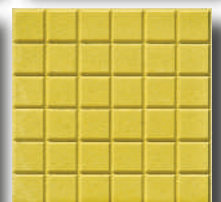
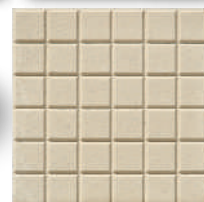
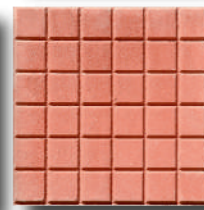
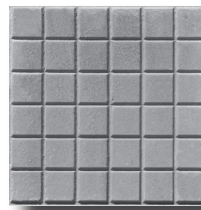
TRETUAR
KARO**DTR 101**
İTALYAN DESEN
(30x30 cm)TRETUAR
KARO**DTR 102**
ÇİÇEK DESEN
(30x30 cm)TRETUAR
KARO**DTR 103**
AHŐAP DESEN
(30x30 cm)TRETUAR
KARO**DTR 104**
KARE KARE DESEN
(30x30 cm)

DIŐ MEKAN TRETUAR TERRAZO KAROLAR



TRETUAR
KARO **DTR 101**
İTALYAN DESEN
(40x40 cm)

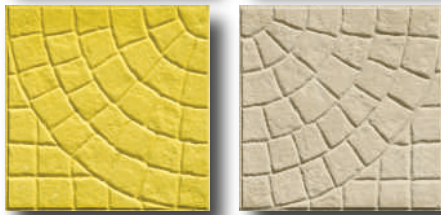
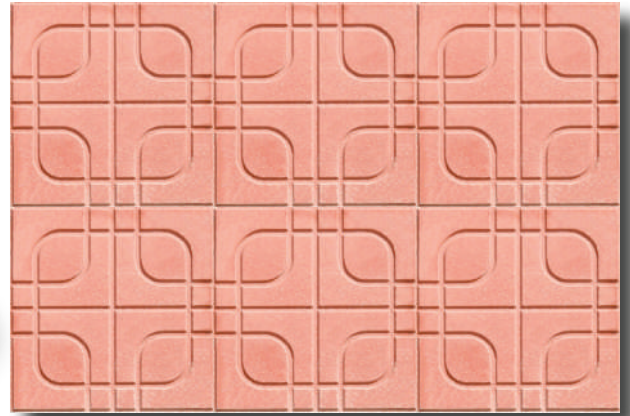

TRETUAR
KARO **DTR 105**
RÖLYEF DESEN
(30x30 cm)

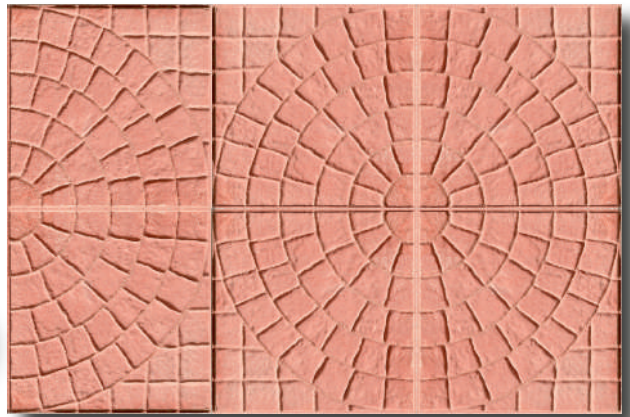

TRETUAR
KARO **DTR 106**
TRAVERTEN DESEN
(30x30 • 40x40 cm)

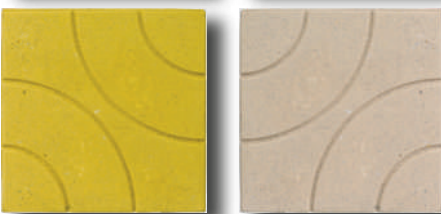

TRETUAR
KARO **DTR 107**
S DESEN
(30x30 cm)

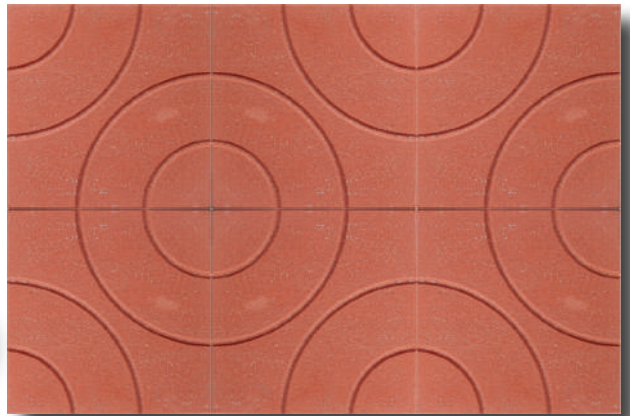

DIŐ MEKAN TRETUAR TERRAZO KAROLAR



TS 13631



PREKAST / MERDİVEN BASAMAKLARI

İÇ ve DIŐ MEKAN PLAKA TİPİ BASAMAKLAR

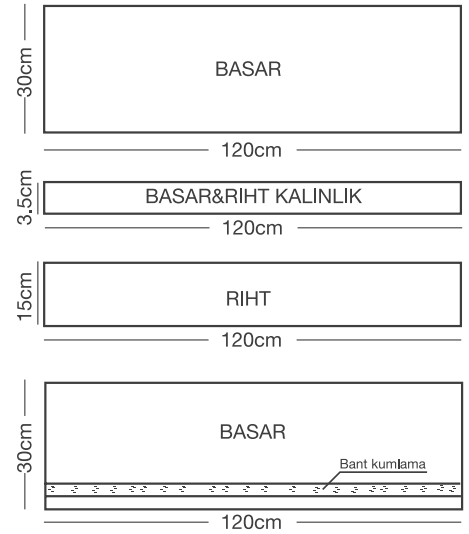
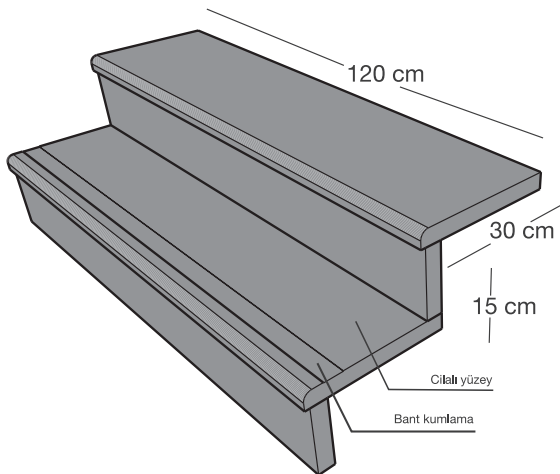

Prekast ürünler 75x120 plakalar şeklinde üretilir. Plakalar talep halinde istenilen ölçülerde ebatlanarak, merdiven basamağı, harpuŐta, küpeŐte, adım taŐı olarak kullanılır. İhtiyaca göre ürün yüzeyine kaymazlık kumlama işlemleri uygulanır.

KÜP TAŞI

Peyzaj çalışmalarında küp taş tek başına kullanılabilir gibi 10x20 ve 20x20 parke taşları ile de kombine yapılabilir. Boyutu küçük olması nedeniyle daha ince bir derz aralığı bırakabilir. Bu da daha estetik bir görünüm sağlar. 10x10 cm ölçülerinde olan küp taş, 6-8 ve 10 cm kalınlığında üretilmektedir.



10*10 cm	Adet / m ²	Kg / m ²	m ² / Palet	Kg / Palet
H= 6 cm	99 Adet	130 kg	16.67 m ²	1.878 kg
H= 8 cm	99 Adet	175 kg	12.22 m ²	2.100 kg
H= 10 cm	99 Adet	210 kg	11.11 m ²	2.335 kg

DİKDÖRTGEN TAŞI

Peyzaj fikirlerinize şekil vermek söz konusu olduğunda, dikdörtgen kilitli parke taşı desen ve tasarım açısından çok fazla alternatif sunar. Ayrıca ağır yüklere maruz kalan zeminler içinde gayet sağlam ve kullanışlıdır.



10*20 cm	Adet / m ²	Kg / m ²	m ² / Palet	Kg / Palet
H= 6 cm	50 Adet	130 kg	15.12 m ²	1.965 kg
H= 8 cm	50 Adet	175 kg	12 m ²	2.100 kg
H= 10 cm	50 Adet	210 kg	10.80 m ²	2.268 kg

KARE TAŞI

Teraslardan havuz kenarlarına, yürüme yollarından, otopark alanlarına yaratıcı peyzaj çalışmaları sunan kare beton parke taşımız, 10x10 küp taş ile de farklı kombin oluşturmaktadır.



20*20 cm	Adet / m ²	Kg / m ²	m ² / Palet	Kg / Palet
H= 6 cm	25 Adet	130 kg	15.6 m ²	2.028 kg
H= 8 cm	25 Adet	175 kg	12 m ²	2.100 kg

PETEK TAŞI

Geometrik şekli ile dış mekânlarda modern tasarımlar sağlayan beton petek taşı, araç ve yaya yoluna farklı stiller katar.

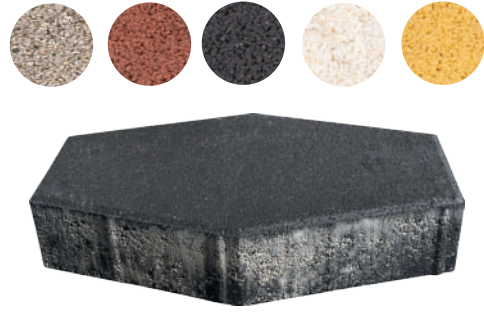

38X22,5	Adet / m ²	Kg / m ²	m ² / Palet	Kg / Palet
H = 8 cm	15 Adet	180 kg	11,67 m ²	2.160 kg

30x60 PARKE TAŞI

Havuz kenarında da kullanıma uygun olan dikdörtgen parke taşı koleksiyonun bir parçası olan 30x60 parke taşı box'ında 15x30 ölçülerinde parke taşı da vardır.



30x60	Adet / m ²	Kg / m ²	m ² / Palet	Kg / Palet
H = 8 cm	5.55 Adet	180 kg	12.6 m ²	2.268 kg

40x60 PARKE TAŞI

Konut, kamu ve park kullanımına yönelik modern peyzaj tasarımları için pürüzsüz bir dokuya sahip olan 40x60 parke taşı adım taşı olarak da kullanılmaktadır.

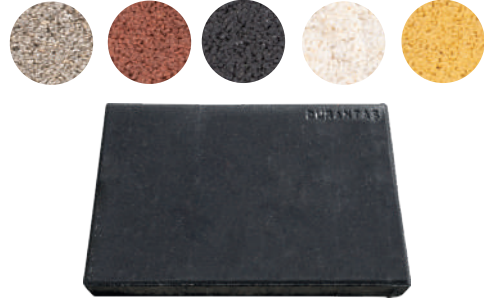

40x60	Adet / m ²	Kg / m ²	m ² / Palet	Kg / Palet
H = 8 cm	4.16 Adet	180 kg	12 m ²	2.160 kg

20x40 PARKE TAŞI

Konut, kamu, park ve bahçelere yönelik modern peyzaj tasarımları için kullanılmaktadır.

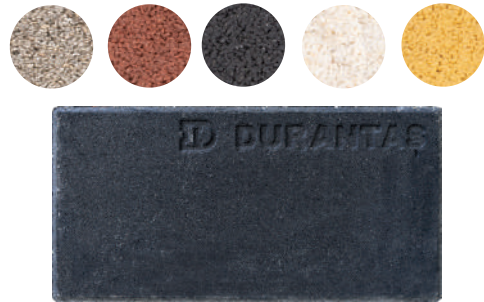

20x40	Adet / m ²	Kg / m ²	m ² / Palet	Kg / Palet
H = 8 cm	12.5 Adet	183 kg	12 m ²	2.200 kg



AŞIK TAŞI

Modern teknolojiler ile üretilen aşık taşı (kilitli parke taşı) birbirini destekleyen ve iç içe geçirilebilen kilitli bir yapıya sahiptir. Araç trafiğinin yoğun olduğu yollarda, kaldırımda, otopark, bahçe ve park düzenlemelerinde kullanılır.

16.5X20	Adet / m ²	Kg / m ²	m ² / Palet	Kg / Palet
H= 6 cm	35 Adet	130 kg	15.6 m ²	2.028 kg
H= 8 cm	35 Adet	175 kg	12 m ²	2.100 kg
H= 10 cm	35 Adet	210 kg	10.8 m ²	2.268 kg



ELİPS TAŞI

Farklı renk ve kalınlık seçenekleri ile kilitli parke modellerinden biri olan elips taşı, geniş dalgalı desen yapısı sayesinde, yürüme yolu, otopark, bahçe ve park düzenlemelerinde tercih edilmektedir.



24.2*26 cm	Adet / m ²	Kg / m ²	m ² / Palet	Kg / Palet
H= 6 cm	26 Adet	130 kg	15.6 m ²	2.028 kg
H= 8 cm	26 Adet	175 kg	12.5 m ²	2.188 kg



S TAŞI

Park, bahçe, otopark ve kaldırım gibi genellikle yayaların bulunduğu alanlarda kullanılan s taşı, dalgalı köşe yapısı ile taşların birbirine sağlam kilitlenmesiyle uzun yıllar kullanılabilir.



12.5*23 cm	Adet / m ²	Kg / m ²	m ² / Palet	Kg / Palet
H= 6 cm	38 Adet	130 kg	15.6 m ²	2.054 kg



BEGONİT TAŞI

Estetik görünümüyle doğal küp taşa alternatif olan begonit taşı, yedi farklı ebatıyla her türlü yol formlarına uygun şekilde döşenebilmektedir.



7 Farklı Ebat	Adet / m ²	Kg / m ²	m ² / Palet	Kg / Palet
H = 8 cm	140 Adet	167 kg	12.6 m ²	2.100 kg



BAKLAVA TAŞI

Dış mekanları geometrik desenler ile modern bir görünüme taşıyan baklava taşı, havuz kenarı, veranda, teras, park bahçe, otopark, araba ve yaya yolu projeleri için uygundur.



20*20 cm	Adet / m ²	Kg / m ²	m ² / Palet	Kg / Palet
H= 6 cm	27.5 Adet	130 kg	15 m ²	1.950 kg
H= 8 cm	27.5 Adet	175 kg	12 m ²	2.188 kg



TRAPEZ TAŞI

20x20 Kare beton parke taşı ile kombine edilen trapez taşının kalınlığı 8 cm'dir. 3 boyutlu görüntüsü ile mimari alanda kullanılan taşlar arasındadır.



10*40 cm 20*20 cm	Adet / m ²	Kg / m ²	m ² / Palet	Kg / Palet
H= 8 cm	25 Adet	170 kg	9.09 m ²	1.950 kg
H= 8 cm	6.25 Adet	170 kg	12 m ²	2.188 kg

ÇİM PARKE TAŞI

İçlerinden çim çıkmasına izin veren yapısı ile, araba yolları ve park alanları için çevre dostu bir seçenektir. Ayrıca erozyonu durdurmanız gereken eğimli alanlar için de kullanılabilir.



40*60*8	Adet / m ²	Kg / m ²	Adet Palet	Kg / Palet
H= 8 cm	4.16 Adet	26 kg	40 Adet	1.300 kg

GÖRME ENGELLİ TAŞI

Hissedilebilir yüzeyi ile görme engelli yayaların yön bulmalarını sağlayan beton parke taş çeşitidir.



40*40 cm	Adet / m ²	Kg / m ²	m ² / Palet	Kg / Palet
H= 6 cm	6.25 Adet	131 kg	14.4 m ²	1.886 kg
H= 8 cm	6.25 Adet	175 kg	12 m ²	2.188 kg

KAYRAK TAŞI

Genelde meydan, cadde ve özel projelerde kullanılan kayrak döşeme taşı farklı renk seçeneği alternatifleride mevcuttur.



40*40 cm	Adet / m ²	Kg / m ²	m ² / Palet	Kg / Palet
H= 5 cm	6.25 Adet	110 kg	14.4 m ²	1.584 kg



KARE PLAKA

Genellikle belediyeler tarafından kaldırımlarda kullanılan bir taştır.



50*50*10	Adet / m ²	Kg / Adet	Palet Adet	Kg / Palet
H= 10 cm	4 Adet	60 kg	40 Adet	2.400 kg



PLAKA CADDE

Kamu, belediyeler ve ağır yüke maruz kalan alanlarda kullanılan bir taştır.



50*100*15	Adet / mtül	Kg / Adet	Palet Adet	Kg / Palet
H= 15 cm	2 Adet	170 kg	12 Adet	2.040 kg

DESENLİ PRES ÇİÇEKLİK

1 PALETTE
3 ADET 40x100x35
6 ADET 40x50x30 VARDIR.



EN: 40CM / BOY: 50CM / YÜKSEKLİK: 35CM
EN: 40CM / BOY: 100CM / YÜKSEKLİK: 35CM

ŞEV TAŞI

Sağlam ve şık görünümüyle, eğimli yerlerde yağmur sularının sel haline dönmesi ve toprak kaymasını önlemek amacıyla kullanılan bir üründür.



23*16.5*36	Adet / m ²	Kg / Adet	Palet Adet	Kg / Palet
H= 16.5 cm	22 Adet	23 kg	72 Adet	1.380 kg

ŞEV ÇİÇEKLİK

Çevre düzenlemesinde dekoratif bir görünüm oluşturan şev çiçeklik, eğimli bölgelerde toprağın kaymasını engelleyen yapı elemanıdır.



40*50*27	Adet / m ²	Kg / Adet	Palet Adet	Kg / Palet
H= 27 cm	7,5 Adet	44 kg	12 Adet	704 kg

KIRMA BLOK

Yapışık bims şeklinde beton olarak üretilip daha sonra özel teknoloji ile birbirinden koparılıp yontma doğal taş deseni verilerek üretilen estetik bir yapı bloğudur.



20*40*20	Adet / m ²	Kg / Adet	Palet Adet	Kg / Palet
H= 20 cm	12.5 Adet	25 kg	108 Adet	2.700 kg

TERRA ÇİÇEKLİK

Çevre düzenlemesinde dekoratif bir görünüm oluşturan terra çiçeklik, eğimli bölgelerde toprağın kaymasını engelleyen yapı elemanıdır.



20*33,5*29	Adet / m ²	Kg / Adet	Palet Adet	Kg / Palet
H= 20 cm	15 Adet	22,5 kg	40 Adet	900 kg



BAHÇE BORDÜRÜ

Bahçe, park, yürüme ve araç yolu gibi alanlarda belirleyici ve ayırıcı görev görmektedir.



20x50x10 15x50x10	Adet / mtül	Kg / Adet	Palet Adet	Kg / Palet
H=20 cm	2 Adet	19 kg	100	1.900 kg
H=15 cm	2 Adet	17 kg	120	2.040 kg



AYIRMA BORDÜRÜ

Değişken hava koşullarına dayanıklı olan ayırma bordürü, bahçe ve çevre düzenlemesinde hem sağlam hem de estetik sonuçlar elde etmenin önemli bir parçasıdır.



20x50x8	Adet / mtül	Kg / Adet	Palet Adet	Kg / Palet
H = 20 cm	2 Adet	15 kg	100	1.500 kg

WASCH BETON BORDÜRÜ

Kullanım alanları genelde bahçe ve yürüyüş yol kenarları olan wash beton bordürü, doğal çakıllı bir bordür ürünü olması sebebiyle estetik ve modern bir bordür taşıdır.



20*50*10	Adet/mtül	Kg / Adet	Palet Adet	Kg / Palet
H = 20 cm	2 Adet	20 kg	80	1.600 kg

STANDART YOL BORDÜRÜ

Dayanıklı, yüksek yapısı ve kalitesiyle yol ile kaldırım arasında döşenmek için zıvanalı olarak tasarlanmış olan standart bordür, belediye bordürü olarak adlandırılır.

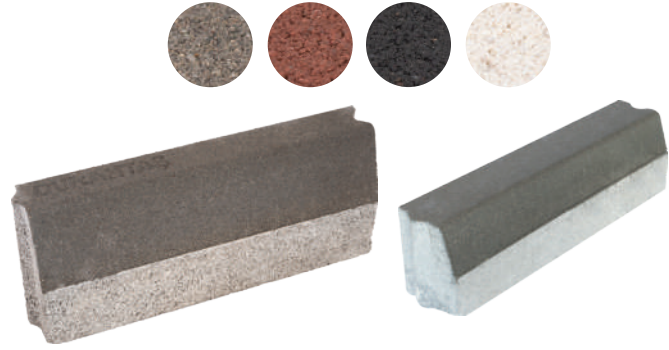

ÖLÇÜ	Adet / mtül	Kg / Adet	Palet Adet	Kg / Palet
20x70x15	1,42 Adet	50 kg	40 Adet	2.000 kg
30x70x15	1,42 Adet	65 kg	21 Adet	1.365 kg
30x75x15	1,33 Adet	75 kg	20 Adet	1.500 kg

YATIK (ANDEZİT TİPİ) BORDÜR

Estetik ve modern peyzaj uygulamalarının vazgeçilmezi olan yatık (andezit tipi) bordür, kaldırım ve refüjleri yoldan ayırmak için kullanılır.

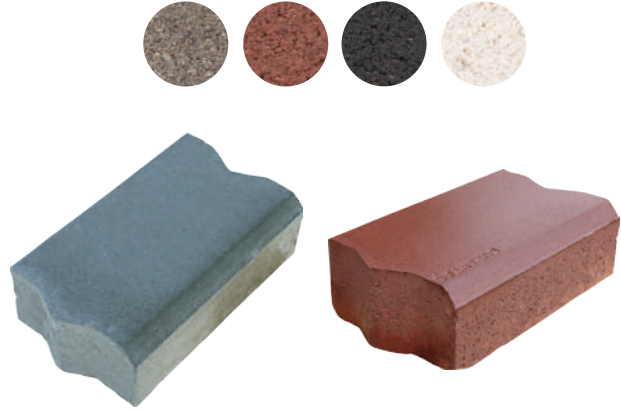

30*50*15	Adet / mtül	Kg / Adet	Palet Adet	Kg / Palet
H = 15 cm	2 Adet	52 kg	40 Adet	2.080 kg

BİTİŞ ve CADDE YOL BORDÜRÜ

Cadde ve sokaklarımızın dayanımı yüksek yapısı ve kalitesiyle üretilerek yol il kaldırım arasına döşenir. Bitiş Bordürü 24x100x10, Cadde Yol Bordürü 24x100x30

CADDE



BİTİŞ

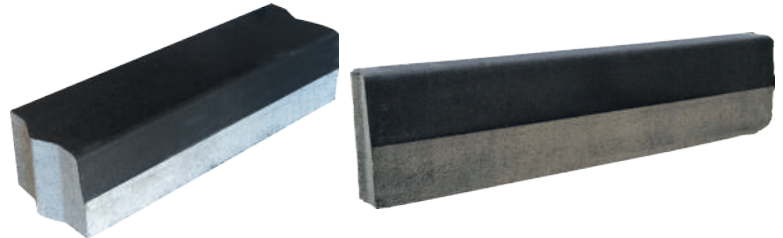

ÖLÇÜ	Adet / mtül	Kg / Adet	Palet Adet	Kg / Palet
24x100x10	1 Adet	130 kg	36 Adet	2.028 kg
24x100x30	1 Adet	175 kg	12 Adet	2.100 kg



YAĞMUR OLUĞU

Yağmur sularının birikmesi ve akıntı problemlerini ortadan kaldırmak için kullanılan yağmur oluğu farklı ölçü ve renkte üretilmektedir.

30*50*8	Adet / mtül	Kg / Adet	Palet Adet	Kg / Palet
H= 8 cm	2 Adet	27 kg	80 Adet	2.160 kg

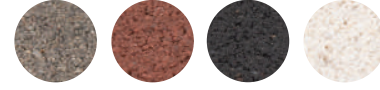

YAĞMUR OLUĞU

Sokak, bahçe, otopark gibi alanlarda yağmur suyunun kontrollü bir şekilde tahliyesi için tasarlanmıştır.

30*30*8	Adet / mtül	Kg / Adet	Palet Adet	Kg / Palet
H= 8 cm	3.33 Adet	14 kg	120 Adet	1.680 kg

KANALET

Küçük kanal olarak kullanılan kanalet pis su, yağmur suyu ve atık sular gibi alt yapılar için kullanılır. Beton veya döküm ızgara kullanılabildiği gibi 8 cm aşık (kilit taşı) ile de kullanılabilir.



28*29*33	Adet / mtül	Kg / Adet	Palet Adet	Kg / Palet
H= 29 cm	3.57 Adet	40.5 kg	27 Adet	1.093 kg

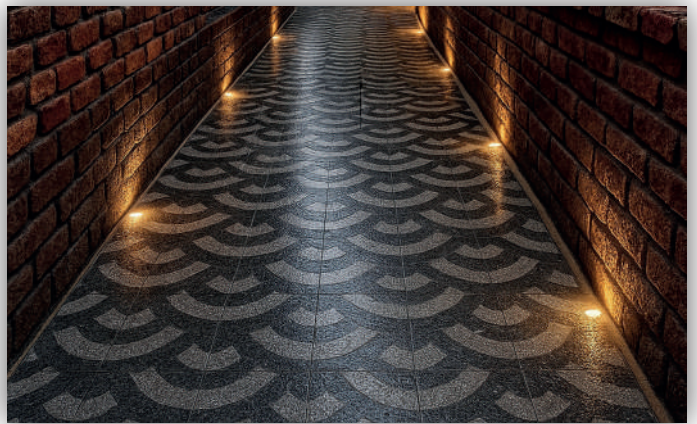
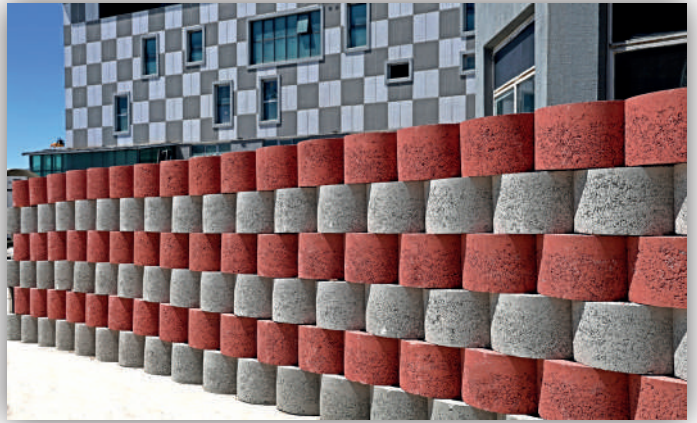



DURANOĞULLARI

BETON ELEMANLARI

www.duranogullari.com



Merkez & Showroom

Aselsan Yolu Üzeri Mehmet Akif Ersoy Mh.
296. Cd. No: 42 Yenimahalle / ANKARA
Tel: 0312 385 38 28
Fax: 0312 385 28 21
info@duranogullari.com

Fabrika

Çubuk Yolu Üzeri Fatih Mh. Yazır Cd.
Süper Sk. No: 4 Çubuk / ANKARA
Tel: 0312 827 15 14
fabrika@duranogullari.com



MERKEZ
KONUM İÇİN
OKUTUNUZ



FABRİKA
KONUM İÇİN
OKUTUNUZ



SOSYAL MEDYA
HESAPLARIMIZDAN
BİZLERİ TAKİP ETMEYİ
UNUTMAYIN

Üretici Firma
TARZ 0312 395 27 17
Mühür - Fotoğraf